



---

# Monteringsanvisning

Glasrekke Aluminium

# Innholdsfortegnelse

Før montering	2
Verktøy	2
Komponenter	3-5
Tegning	4-5
Montering firkantede stolper	6-7
Montering runde stolper	8-9
Råd om vedlikehold	10

## Før montering

- Les hele monteringsanvisningen før du begynner monteringen! Hvis anvisningen ikke følges, vil produktet kanskje ikke fungere optimalt, og garantien vil ikke gjelde.
- Willab Garden forbeholder seg retten til å endre materialer, konstruksjon og design.
- Kontroller at leveransen er komplett, og at ingenting har blitt skadet under frakt.
- Skru for innfesting i fundament medfølger ikke. Forhør deg med en fagmann angående riktig festemetode for ditt underlag.

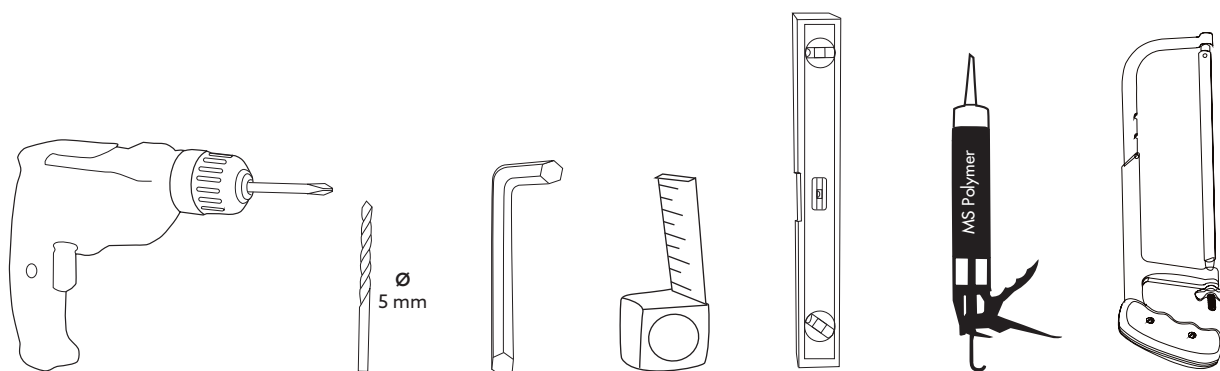

# Komponenter

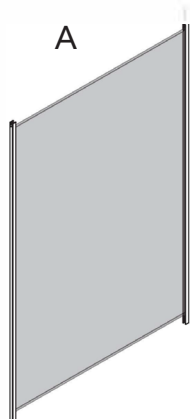

8mm Laminert Glass  
100 x 90,5 cm  
741070 / 741040  
741079 / 741049

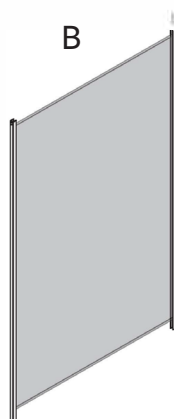

8mm Laminert Glass  
90 x 90,5 cm  
741970 / 741940  
741979 / 741949

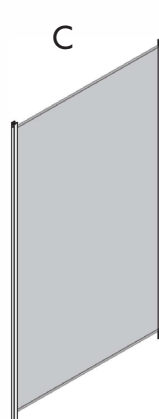

8mm Laminert Glass  
80 x 90,5 cm  
741870 / 741840  
741879 / 741849

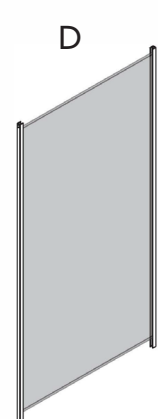

8mm Laminert Glass  
70 x 90,5 cm  
741770 / 741740  
741779 / 741749

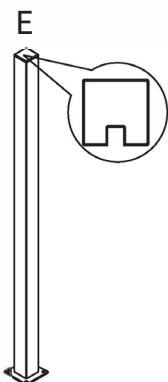

Endestolpe  
50 x 50 x 990 mm  
742071 / 742041

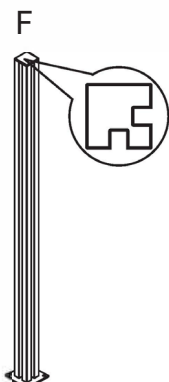

Hjørnestolpe  
50 x 50 x 990 mm  
742073 / 742043

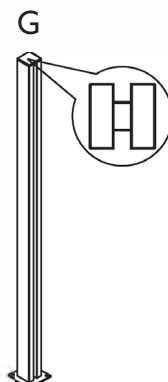

Midtstolpe  
50 x 50 x 990 mm  
742072 / 742042

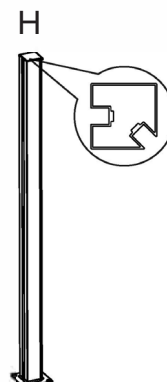

Hjørnestolpe 45°  
50 x 50 x 990 mm  
742075 / 742045

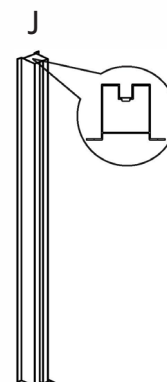

Endestolpe for  
veggtilslutning  
50 x 80 x 990 mm  
742074 / 742044

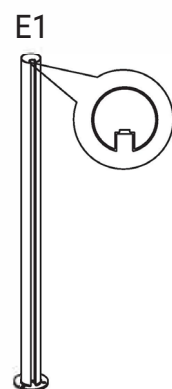

Endestolpe  
50 x 50 x 990 mm  
744071 / 744041

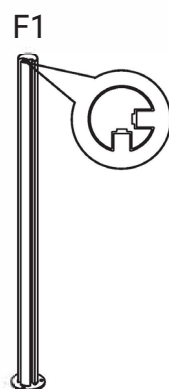

Hjørnestolpe  
50 x 50 x 990 mm  
744073 / 744043

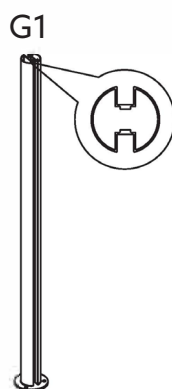

Midtstolpe  
50 x 50 x 990 mm  
744072 / 744042

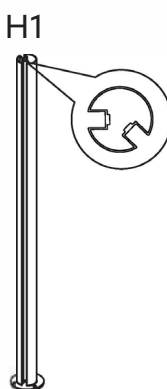

Hjørnestolpe 45°  
50 x 50 x 990 mm  
744075 / 744045

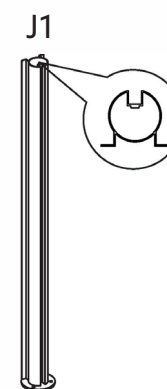

Endestolpe for  
veggtilslutning  
50 x 80 x 990 mm  
744074 / 744044

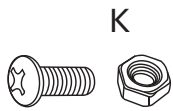

M4 x 10 mm  
M4 Bult

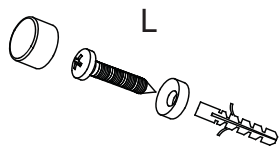

ST4 x 35 mm



Ø4.2 mm

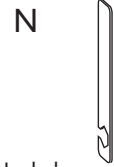

Nyckel

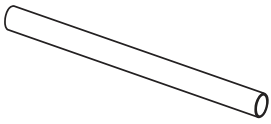

Overligger Lengde 101 cm  
743071 / 743041 / 743081

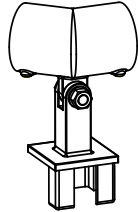

Hjørneholder til overligger  
45°  
743077 / 743047

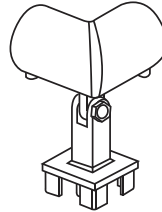

Hjørneholder til overligger  
90°  
743076 / 743046

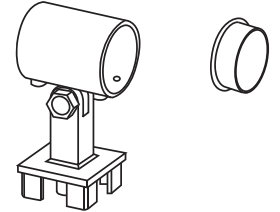

Rett holder med endelås  
743075 / 743045

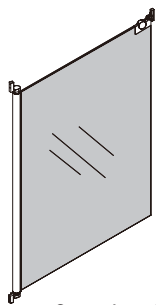

8mm Laminerad Glassgrind  
Med lås  
900 x 905 mm  
741140 / 741170  
741149 / 741179

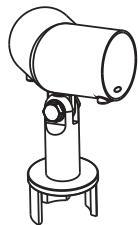

Hjørneholder til overligger  
45°  
745077 / 745047

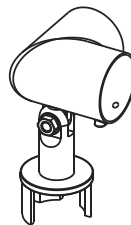

Hjørneholder til overligger  
90°  
745076 / 745046

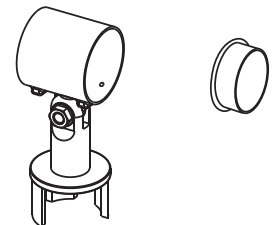

Rett holder med endelås  
Mitt med täcklock  
745075 / 745045

- Glassrekkverkets overligger skal kappes cc -10 mm fra stolpen.

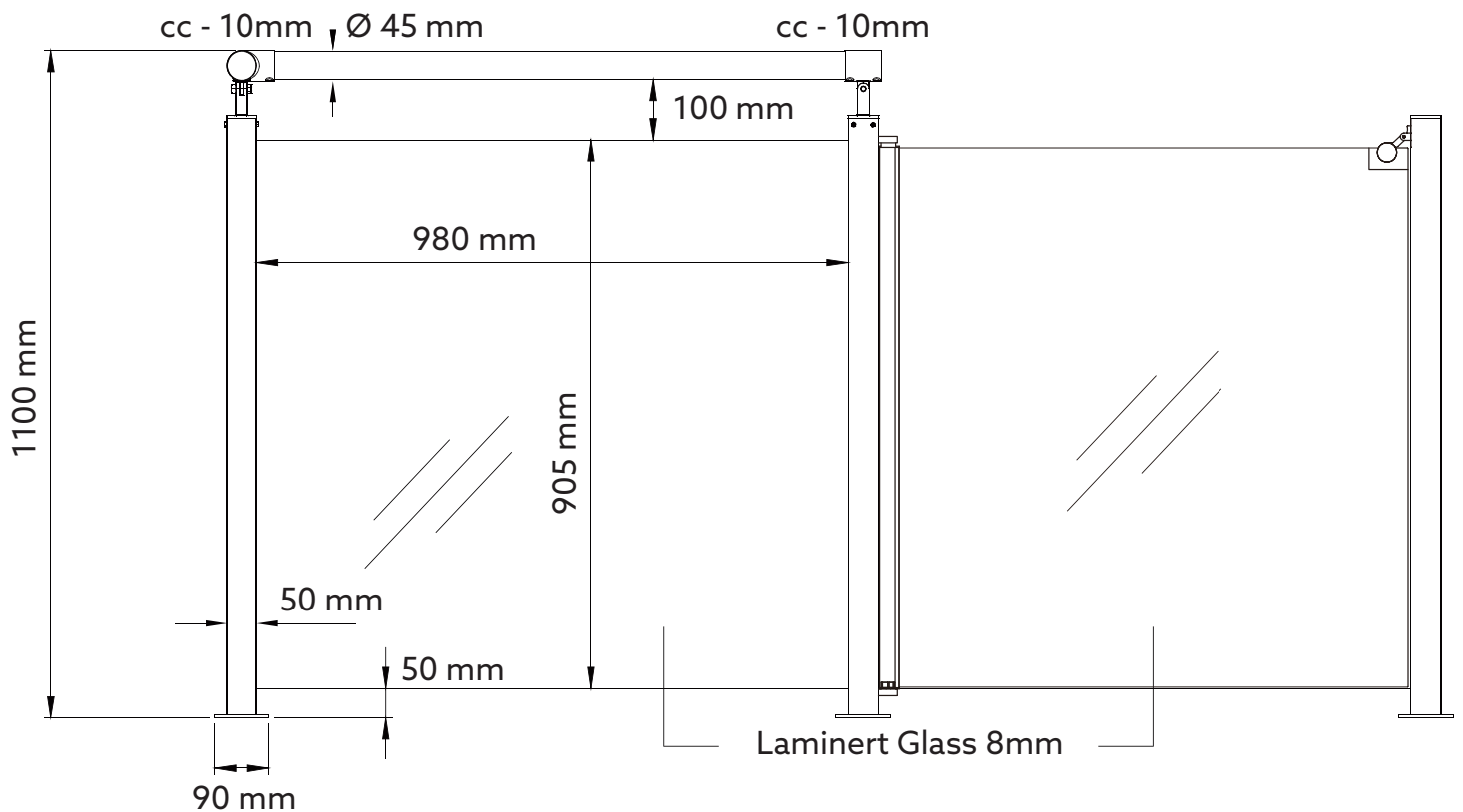

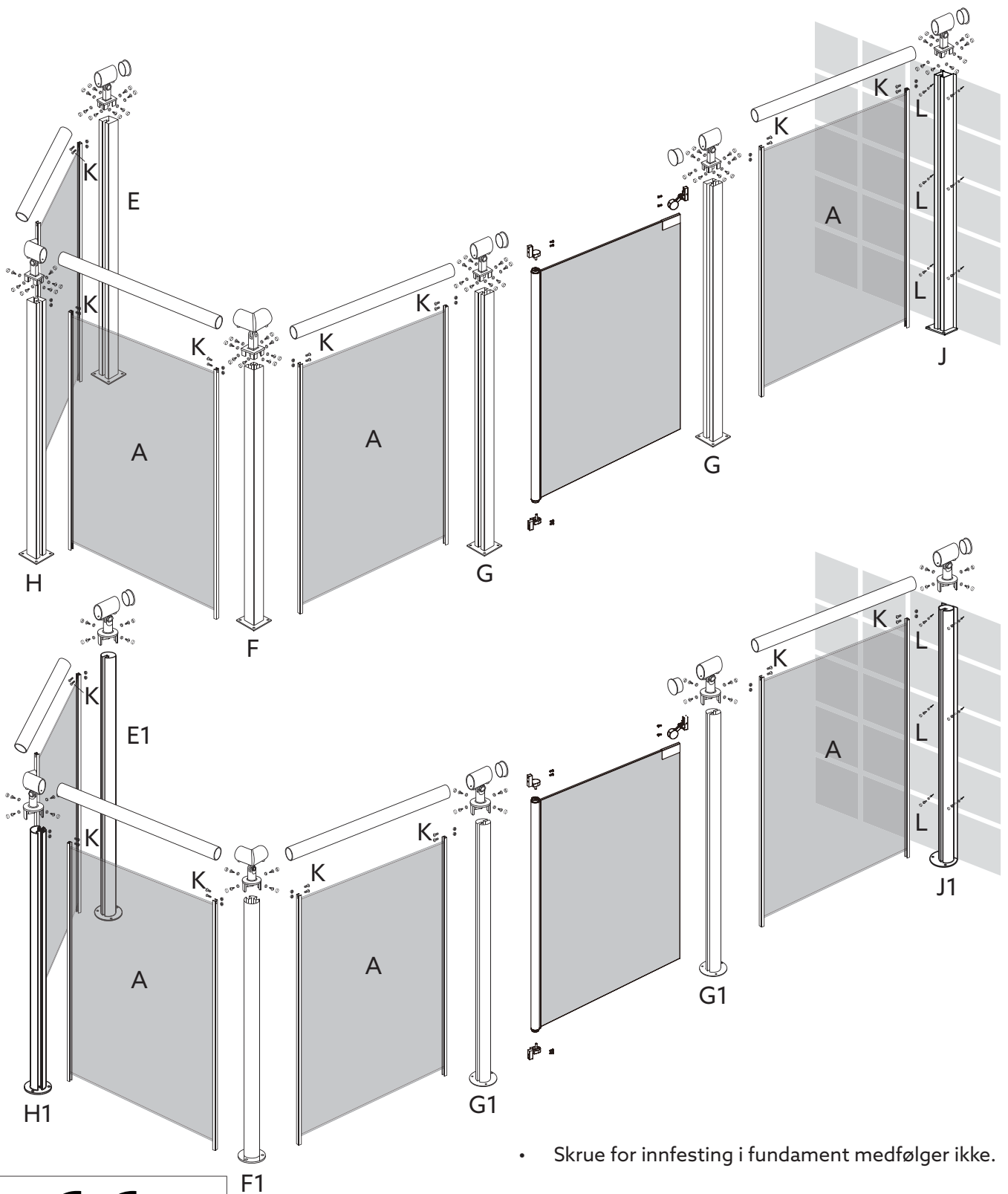

• Skruer for innfesting i fundament medfølger ikke.

<b>CE</b>	
<small>GUANGZHOU HUAFENG SAFETY GLASS CO., LTD          NO. 68, BIG BRIDGE STREET, XILANG,          LIWAN DISTRICT, GUANGZHOU P.R. CHINA</small>	
14	
EN 14449	
Laminated glass, intended to be used in buildings and shower enclosure	
<b>Characteristics</b>	
Resistance to fire	: NPD
Reaction to fire	: A1
External fire performance	: NPD
Bullet resistance	: NPD
Explosion resistance	: NPD
Burglar resistance	: NPD
Pendulum body impact resistance	: EN 12600 1(B)1
Resistance against sudden temperature changes and temperature differentials	: NPD
Wind, snow, permanent and imposed load resistance	: NPD
Direct airborne sound insulation	: NPD
Thermal properties	: NPD
Radiation properties<sup>[c]</sup>1]	: NPD
- Light transmission and reflection	
- Solar energy characteristics	
Declaration of Performance No.	: 001-CPR-201406



### Sikkerhetsadvarsel:

- Glassrekkverket er kun til utendørsbruk.
- Glassrekkverket må alltid festes ordentlig i bakken/gulvet.
- Glassrekkverket er konstruert for bruk på bakkenivå. Må ikke brukes der bakken er ujevn.

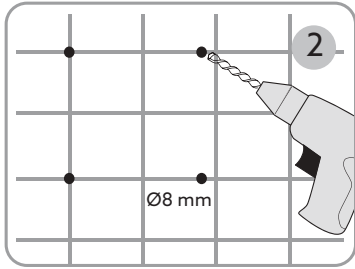
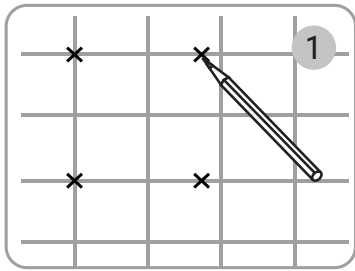

- Skru for innfesting i fundament medfølger ikke.

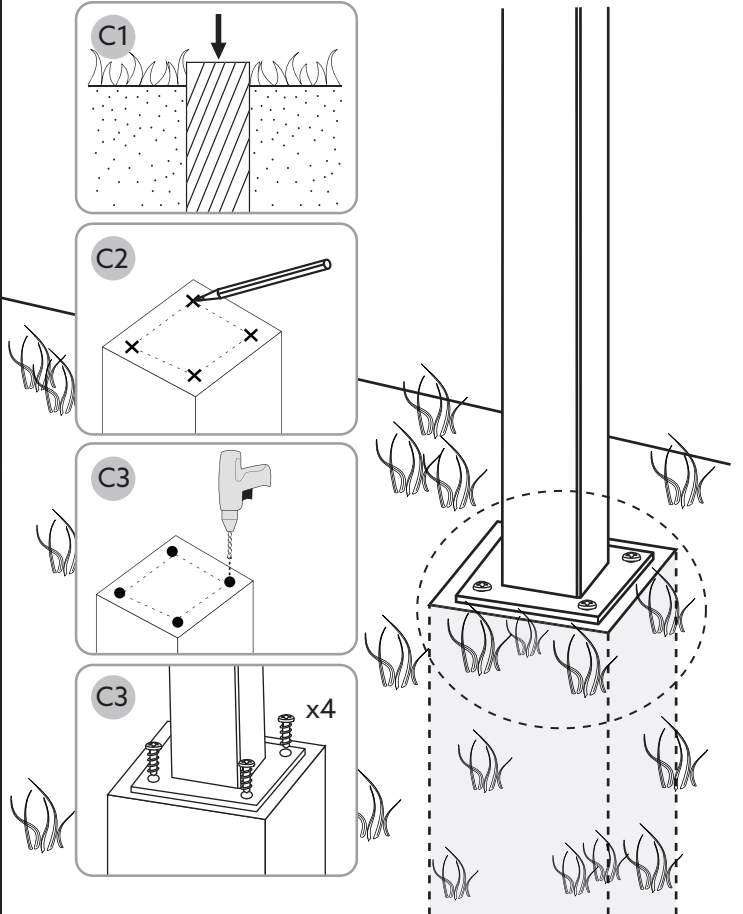
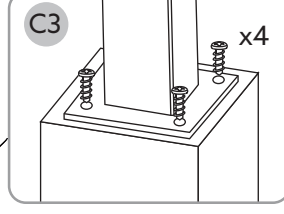
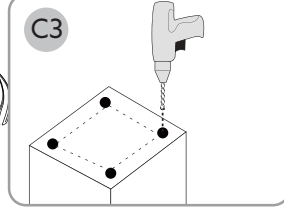
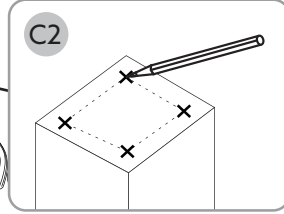
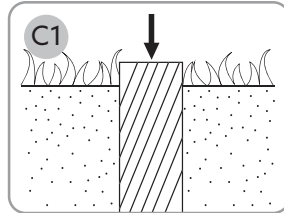
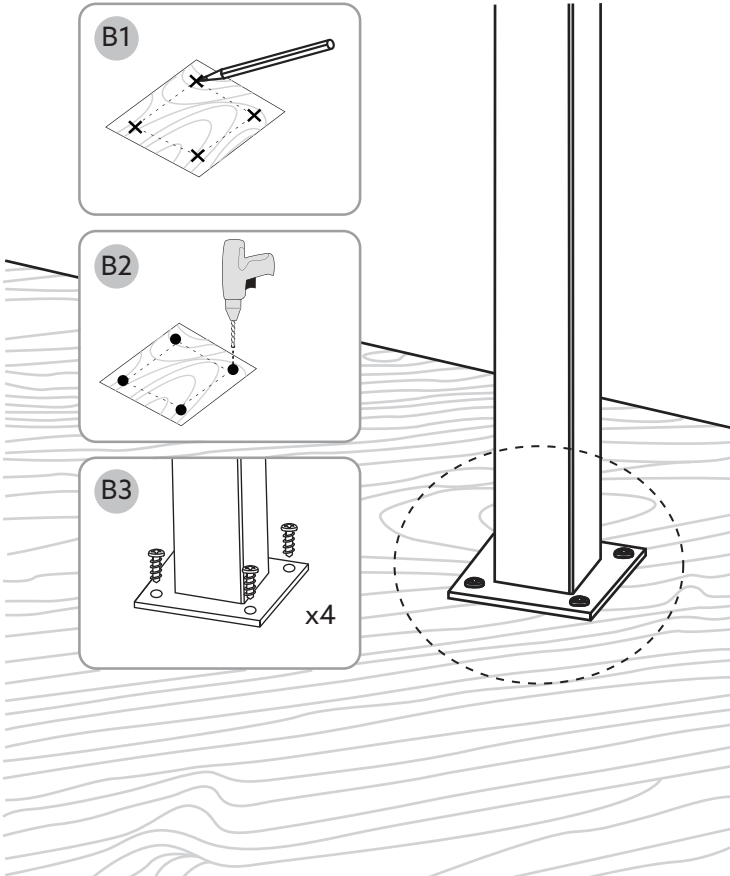
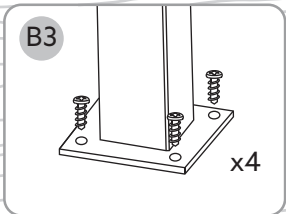
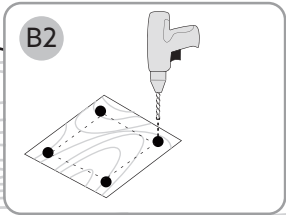
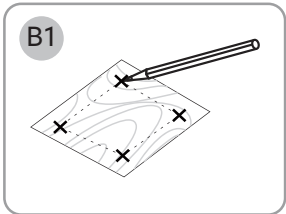
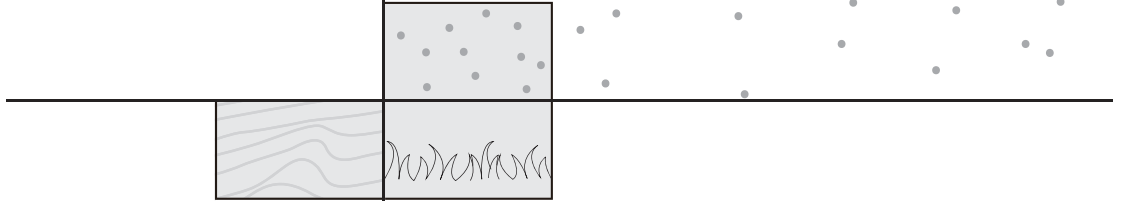
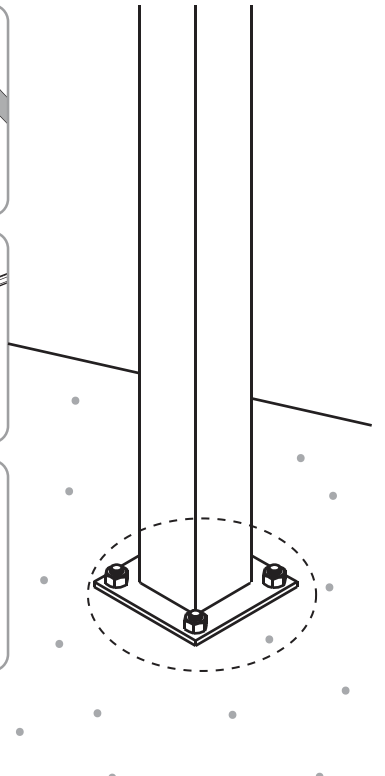
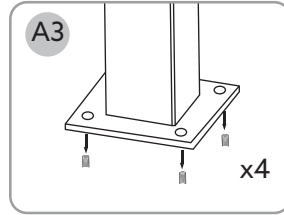
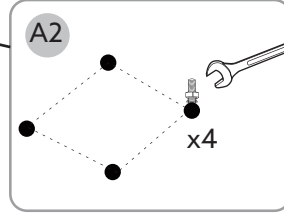
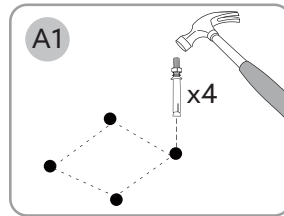
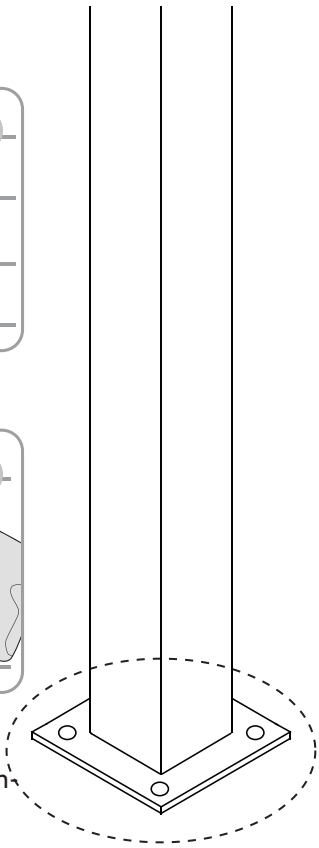

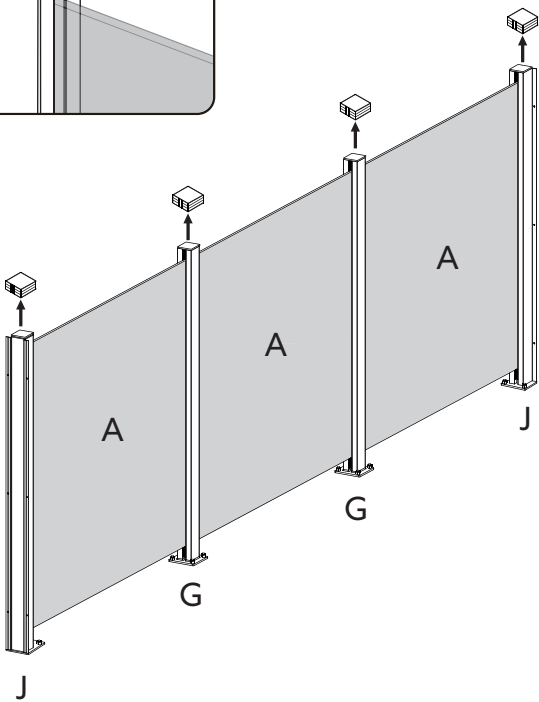
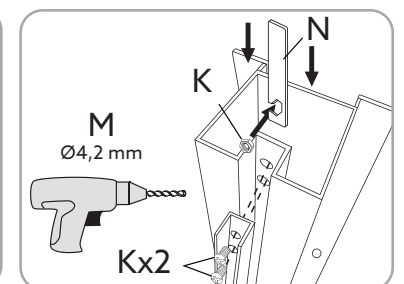
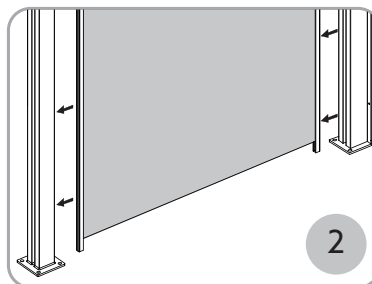
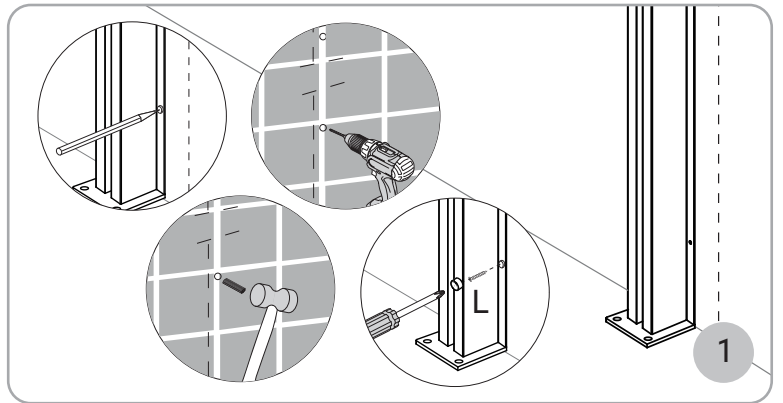
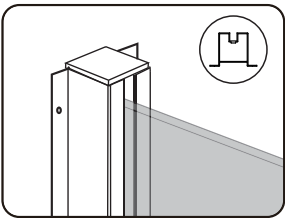
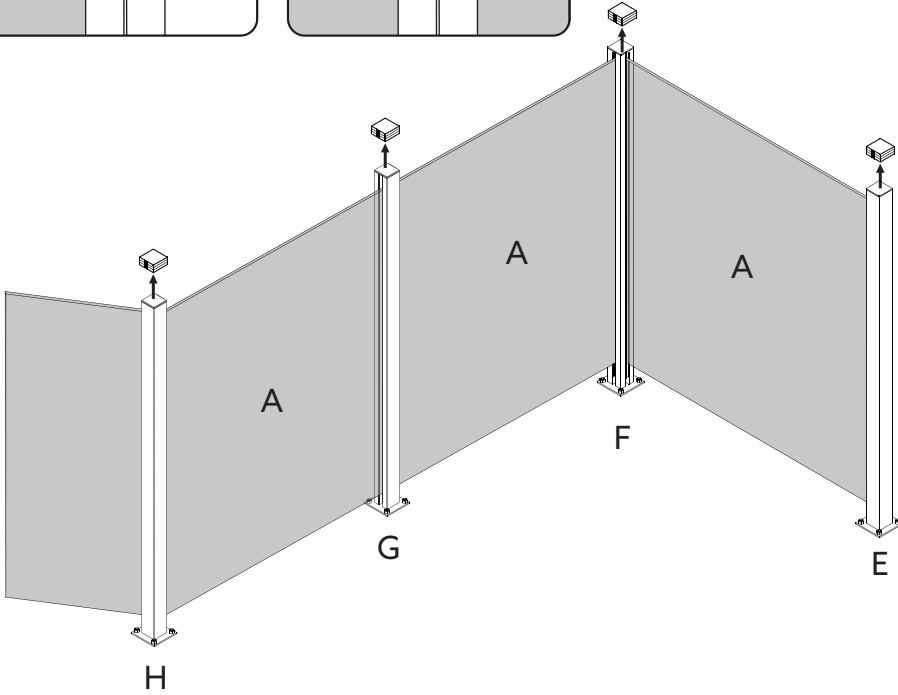
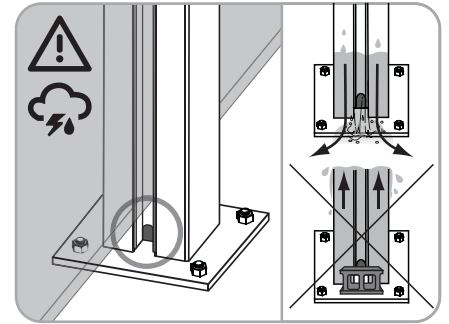
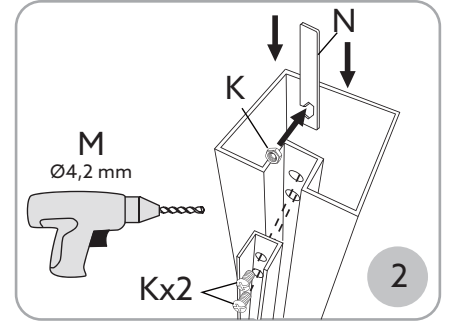
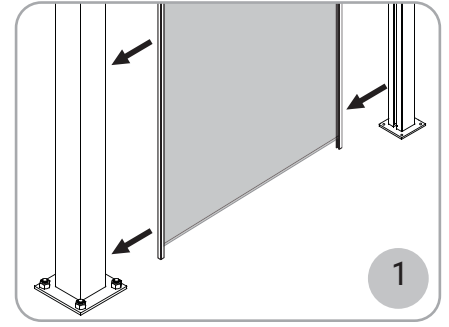
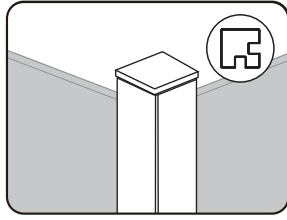
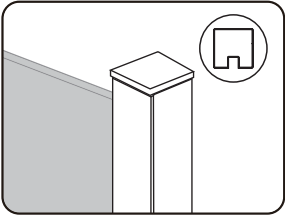
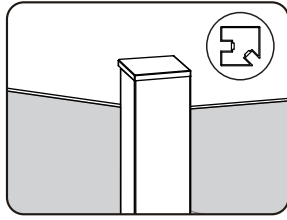
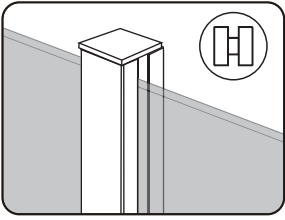

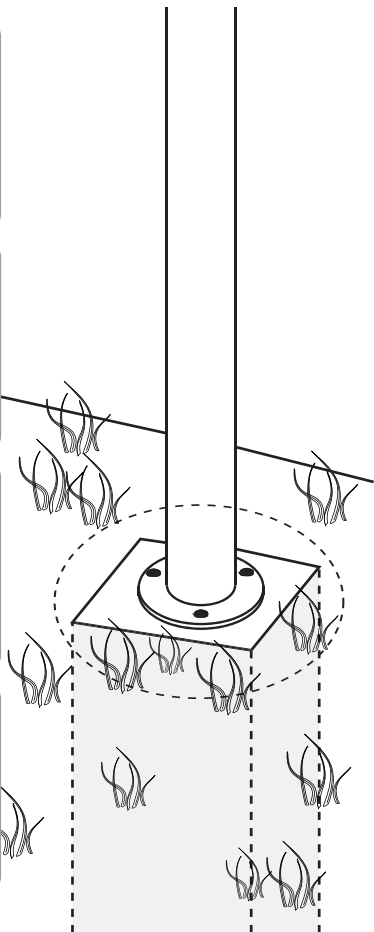
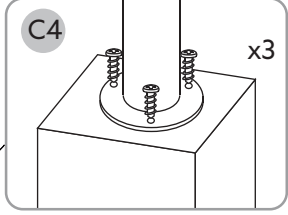
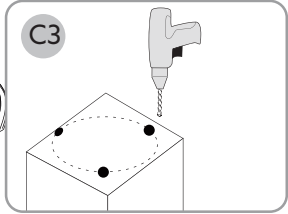
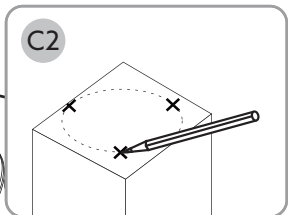
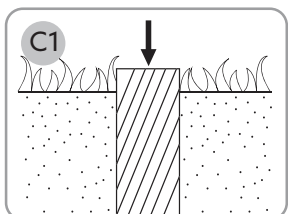
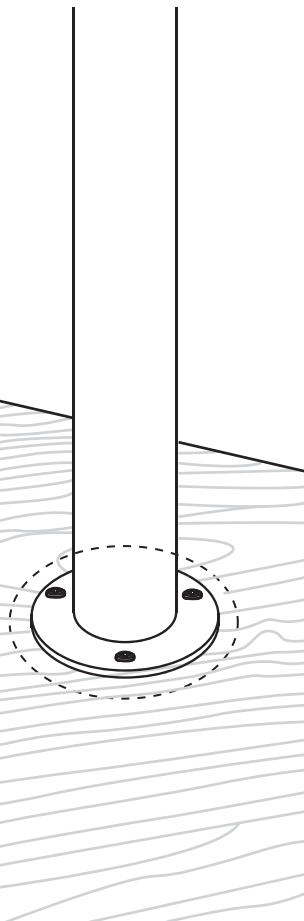
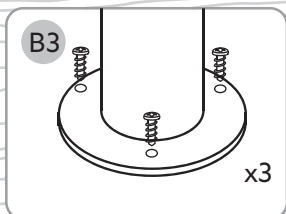
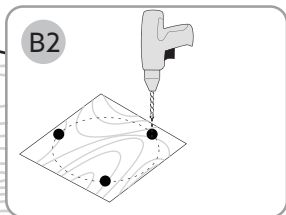
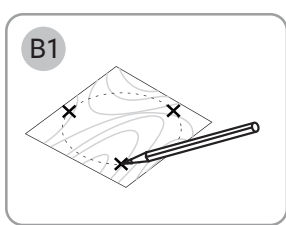
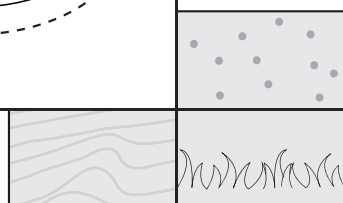
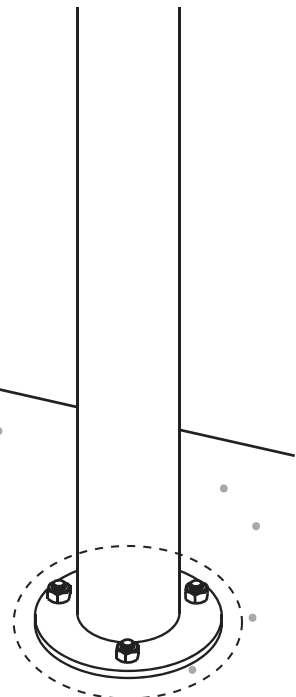
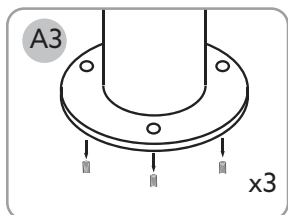
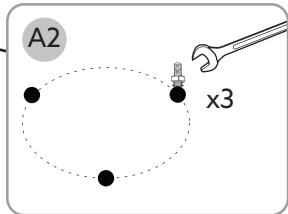
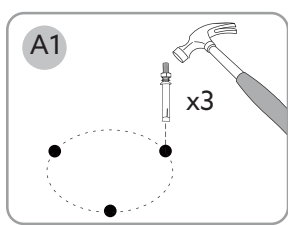
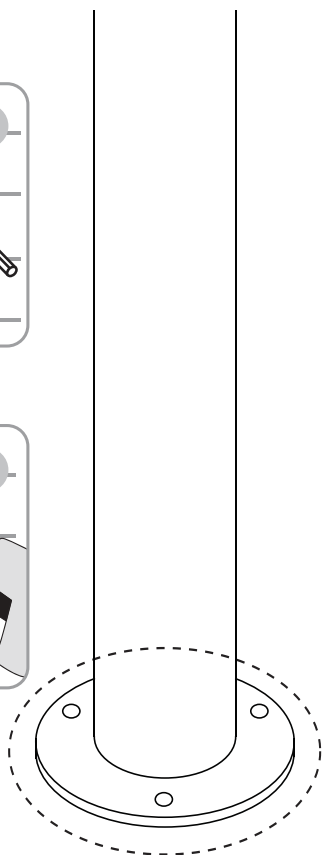
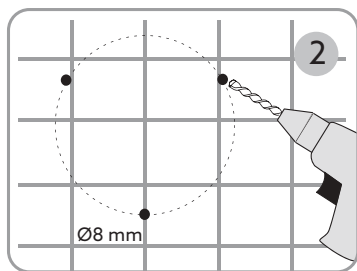
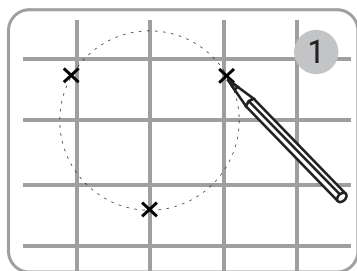



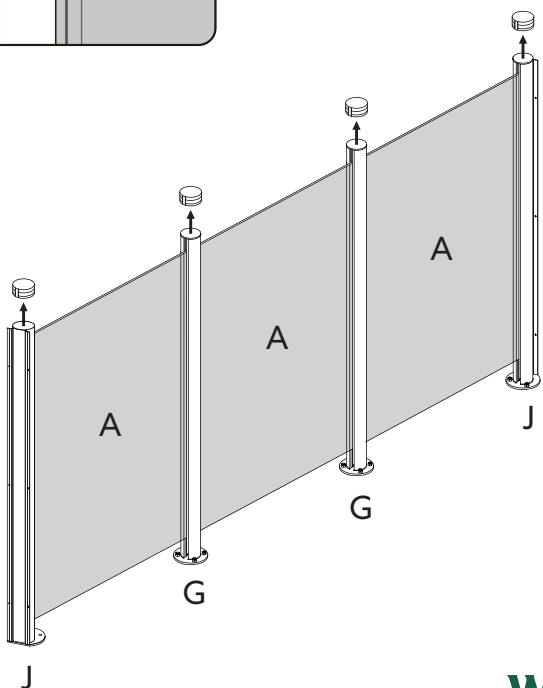
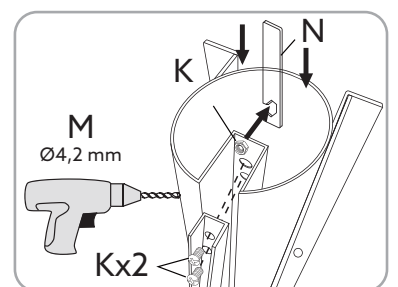
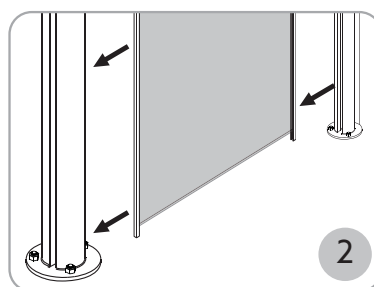
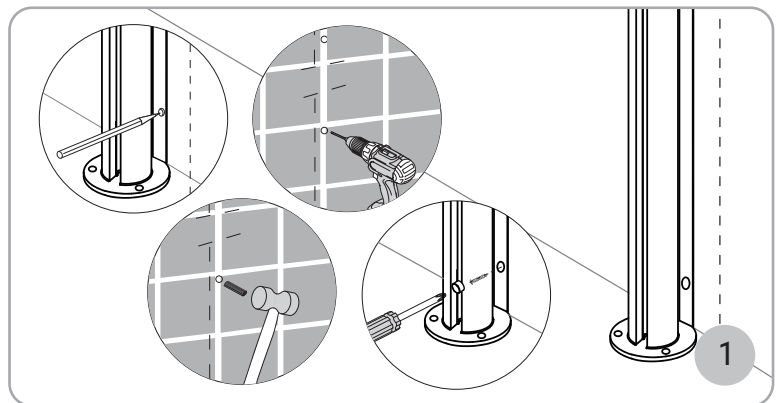
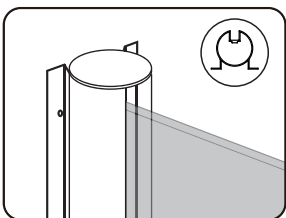
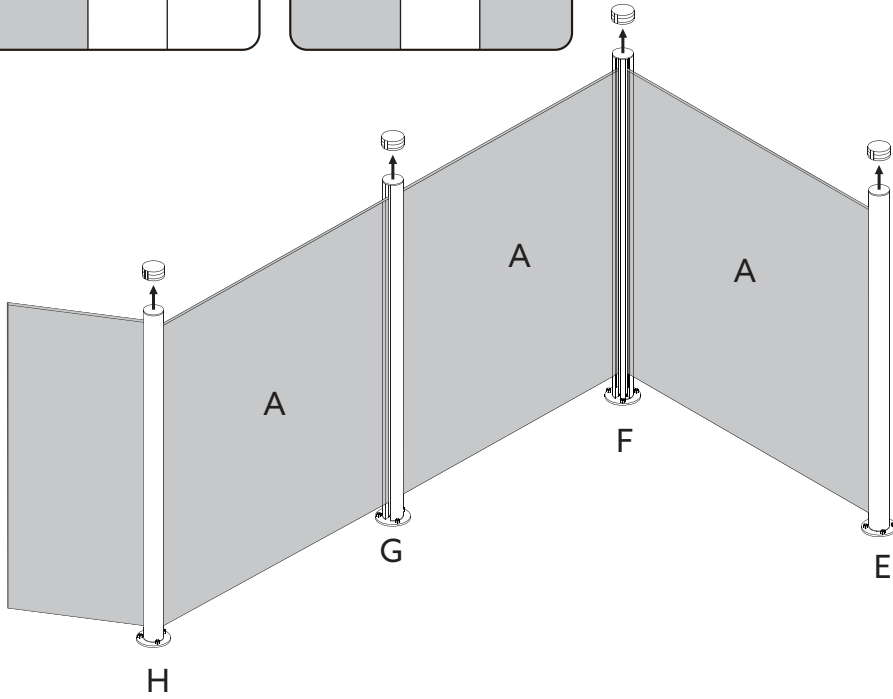
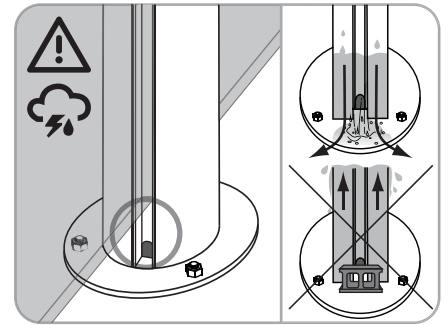
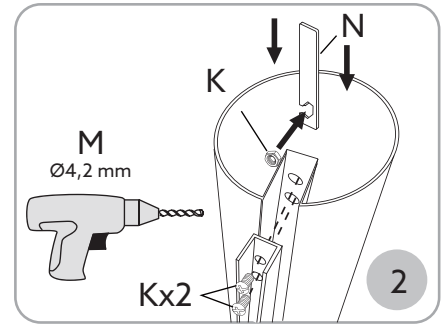
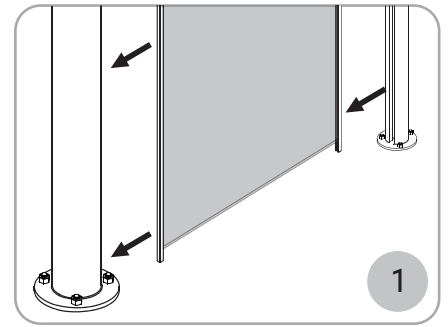
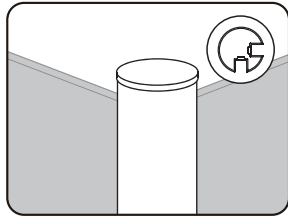
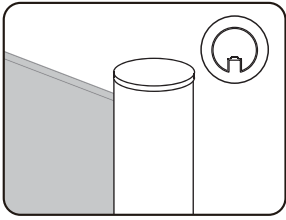
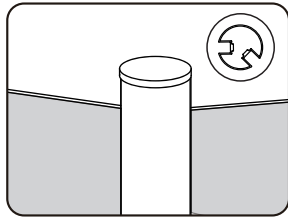
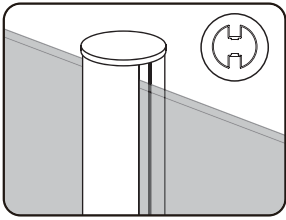

# Råd om vedlikehold

## Glass

- Glassene skal rengjøres som vanlig glass.
- Bruk vanlig middel for vindusvask, rikelig med vann og en myk og lofri klut eller gumminal.
- Rødsprit eller aceton kan løse opp visse typer smuss. Et skånsomt sølveller metallpussemiddel kan brukes til å polere bort andre typer smuss. Pussemiddelet vaskes bort med rødsprit. Tørk deretter av glasset på vanlig måte. Ikke bruk skrape, metallgjenstander eller stålull for å skrape bort gjenstridig smuss.
- Metallavleiringer, som eventuelt vises som riper, fjernes med ensvak syreløsning, f.eks. 5-10 % saltsyre. Gjelder bare for energiglass.

## Aluminiumprofiler

- Bruk mild såpe, oppvaskmiddel eller bare vanlig vann holder til rengjøring av profilene.
- Fjern skitt som kan forårsake skade på sporprofiler og hjul.
- Dersom gummilistene rundt glasspartiene gir fra seg farge på profiler og reisverk, benytt limvask for rengjøring.

OBS! For å unngå personskader og fuglekollisjoner anbefaler vi at f.eks. våre glassdekorasjoner "rovfugl" eller "svale" appliseres på alle glassyter.

